



Badger Meter

Fire Service Strainer

Model 7000 AFSS, Sizes 3, 4, 6, 8 and 10 inch

DESCRIPTION

Protect your water systems from damage caused by debris with the Badger Meter® 7000 AFSS Fire Service Strainer. The 7000 AFSS is used in conjunction with a water spray system to protect the system against clogging that can be caused by particles fouling the small discharge opening of the sprinkler heads. This type of strainer is usually installed upstream of most devices in the system including Meters, Backflow Preventers (or Detector Check Valves), and Flow Alarms, in order to protect these devices from damage caused by large particles.

APPROVALS

UL 321 and FM class 5551 approved

FEATURES AND BENEFITS

- Large solids trap to minimize screen blockage
- 304 SST strainer element
- Sizes: 3, 4, 6, 8 and 10 inch
- Rated working pressure: 175 psi
- Temperature range: 140° F
- Body material: Corrosion resistant fusion-bonded epoxy coated steel
- Screen characteristics: 304 SST, 0.25 diameter perforation
- Flanges AWWA Class D
- Stainless steel flushing ports both sides with AWWA lead-free bronze alloy plugs, unless otherwise specified (optional flushing valves available)
- Stainless steel bypass ports both sides with AWWA lead-free bronze alloy plugs unless otherwise specified (3 inch not available with bypass ports)
- Trim hardware: Zinc-plated, carbon steel bolts (optional hardware: 302/304 stainless steel bolts)

MATERIALS

- Body and cover: Fusion-bonded, epoxy-coated steel
- Strainer element: 304 stainless steel
- Cleanout plug: Stainless steel or lead-free bronze alloy



SPECIFICATIONS

The strainer is designed to permit removal of the filter for replacements and repair without removing the body from the line. A flush outlet port is provided with each strainer. The filter withstands 125 psi when plugged. Friction loss does not exceed 10 psi when tested with foreign material (gravel) equal to 2-1/2 feet of filled pipe trapped in the strainer. Open screen area is at least 6.0 times greater than the nominal pipe size open area. Friction loss is less than 3 psi at rated flow when tested with clean filter and water. The strainer is rated for working pressures up to 175 psi.

HEADLOSS CHARTS

*Approximate headloss at the UL rated flow

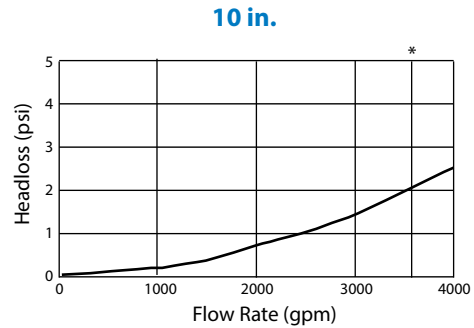
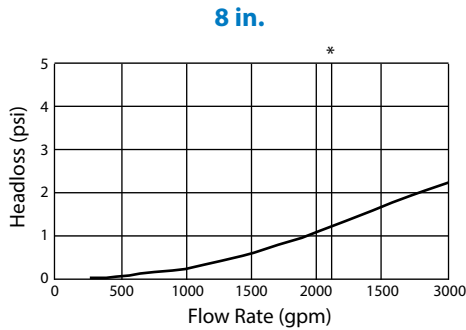
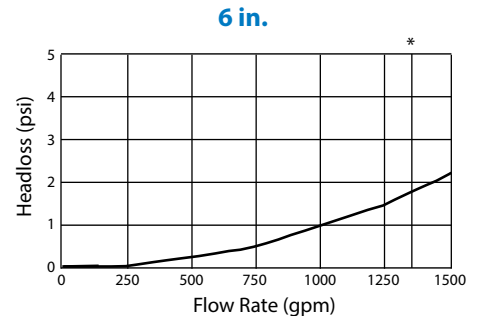
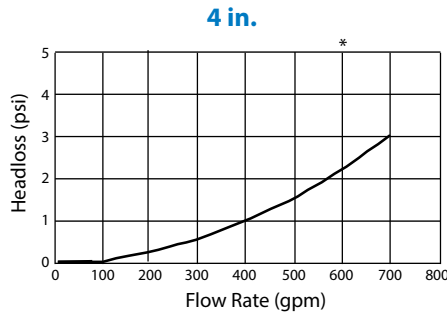
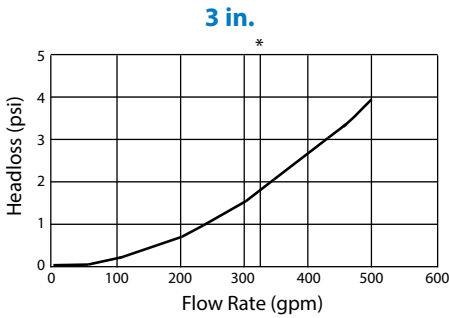

DIMENSIONS

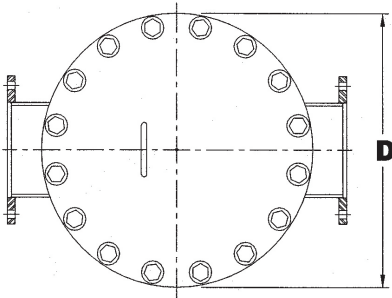

Top View Dimensions	
Main Valve Size (in.)	Diameter D (in.)
3	13-1/2
4	13-1/2
6	19
8	25
10	27-1/2

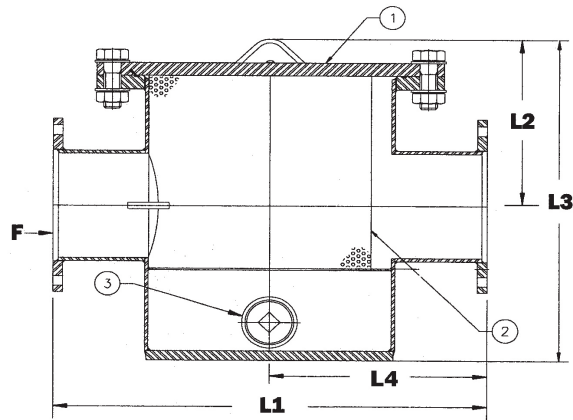

Dimensions								
Max Rated Flow (gpm)	UL Rated Flow (gpm)	Size (in.)	L1 (in.)	L2 (in.)	L3 (in.)	L4 (in.)	Weight (lb)	STD-Perf Dia.(in.)
450	325	3	14-1/4	10-5/8	20-5/8	7-1/8	70	1/4
1000	600	4	11-3/8	10-5/8	20-5/8	5-11/16	120	1/4
2000	1350	6	18-5/8	11-3/4	23	8-9/16	232	1/4
3500	2100	8	23	13-1/2	26-1/4	10-1/2	500	1/4
5500	3600	10	26-5/16	15	30-1/3	12-3/8	570	1/4

Making Water Visible®

Making Water Visible is a registered trademark of Badger Meter, Inc. Other trademarks appearing in this document are the property of their respective entities.

Due to continuous research, product improvements and enhancements, Badger Meter reserves the right to change product or system specifications without notice, except to the extent an outstanding contractual obligation exists. © 2016 Badger Meter, Inc. All rights reserved.

www.badgermeter.com

The Americas | Badger Meter | 4545 West Brown Deer Rd | PO Box 245036 | Milwaukee, WI 53224-9536 | 800-876-3837 | 414-355-0400

México | Badger Meter de las Américas, S.A. de C.V. | Pedro Luis Ogazón N°32 | Esq. Angelina N°24 | Colonia Guadalupe Inn | CP 01050 | México, DF | México | +52-55-5662-0882

Europe, Middle East and Africa | Badger Meter Europa GmbH | Nurtlinger Str 76 | 72639 Neuffen | Germany | +49-7025-9208-0

Europe, Middle East Branch Office | Badger Meter Europe | PO Box 341442 | Dubai Silicon Oasis, Head Quarter Building, Wing C, Office #C209 | Dubai / UAE | +971-4-371 2503

Czech Republic | Badger Meter Czech Republic s.r.o. | Mařikova 2082/26 | 621 00 Brno, Czech Republic | +420-5-41420411

Slovakia | Badger Meter Slovakia s.r.o. | Racienska 109/B | 831 02 Bratislava, Slovakia | +421-2-44 63 83 01

Asia Pacific | Badger Meter | 80 Marine Parade Rd | 21-06 Parkway Parade | Singapore 449269 | +65-63464836

China | Badger Meter | 7-1202 | 99 Hangzhong Road | Minhang District | Shanghai | China 201101 | +86-21-5763 5412

Switzerland | Badger Meter Swiss AG | Mittelholzerstrasse 8 | 3006 Bern | Switzerland | +41-31-932 01 11